

A-A (1 : 5)

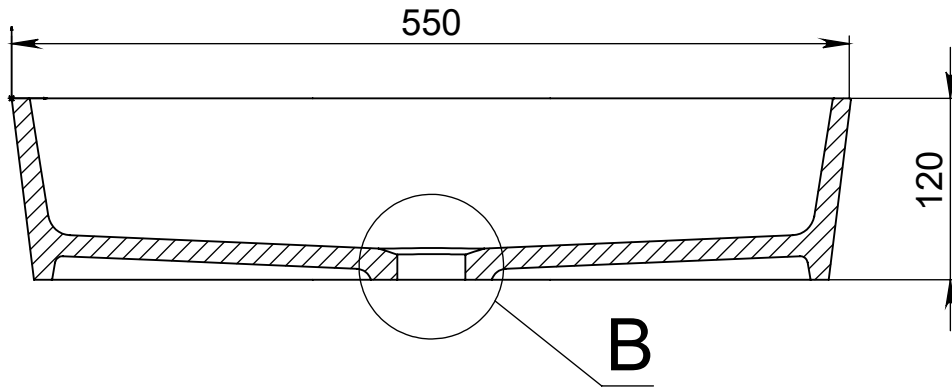

B (1 : 2)

